

TT SCHOOL DEI RICERCATORI IRCCS

Quarta edizione – 3 dicembre 2020

ORIENTARSI TRA SOFTWARE E APP

Laura Spinardi, Ph.D, RTPP



Fondazione IRCCS Ca' Granda
Ospedale Maggiore Policlinico

Sistema Socio Sanitario



Regione
Lombardia

Diritti di Proprietà Industriale

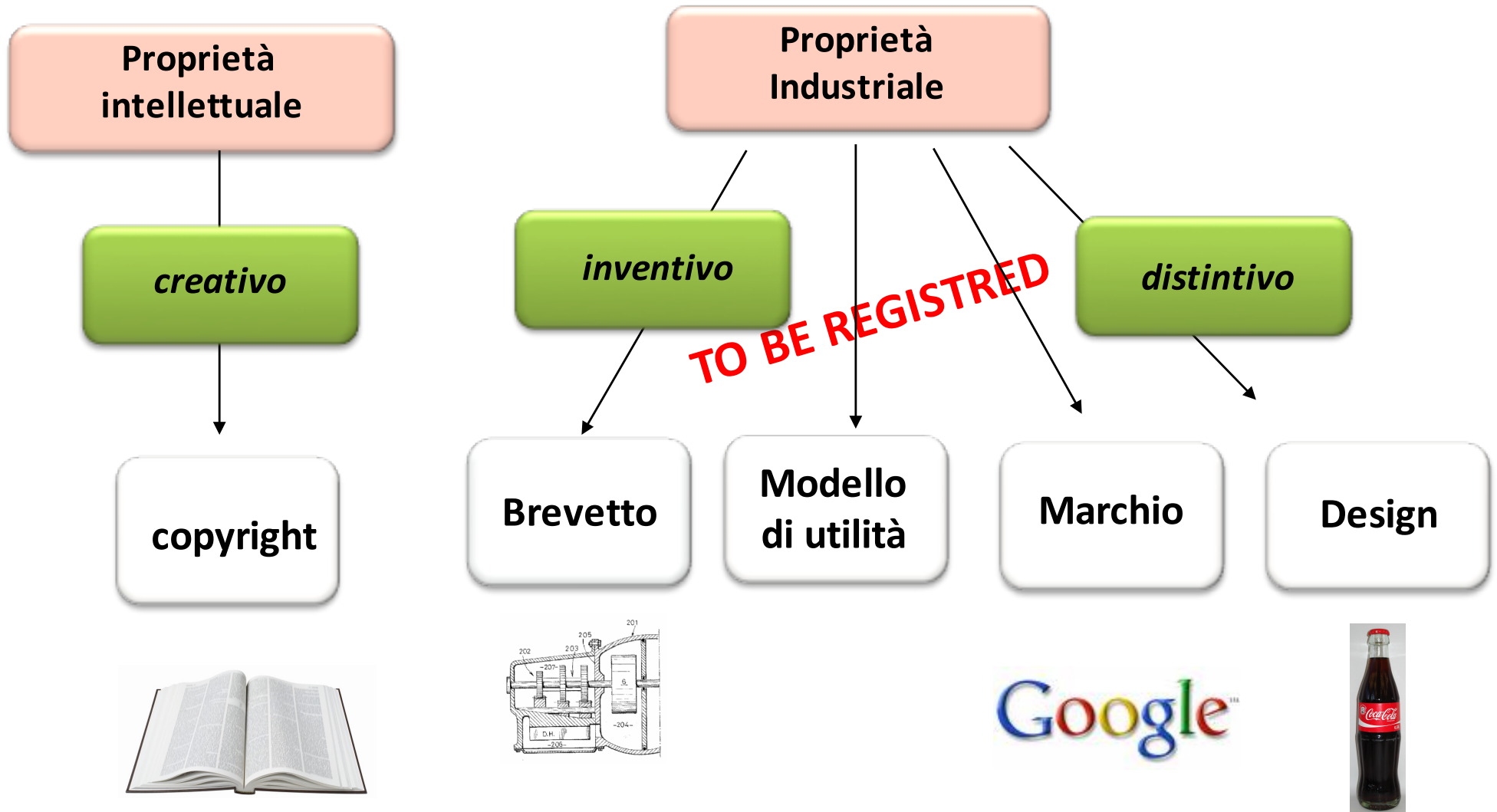

Diritti di Proprietà Intellettuale

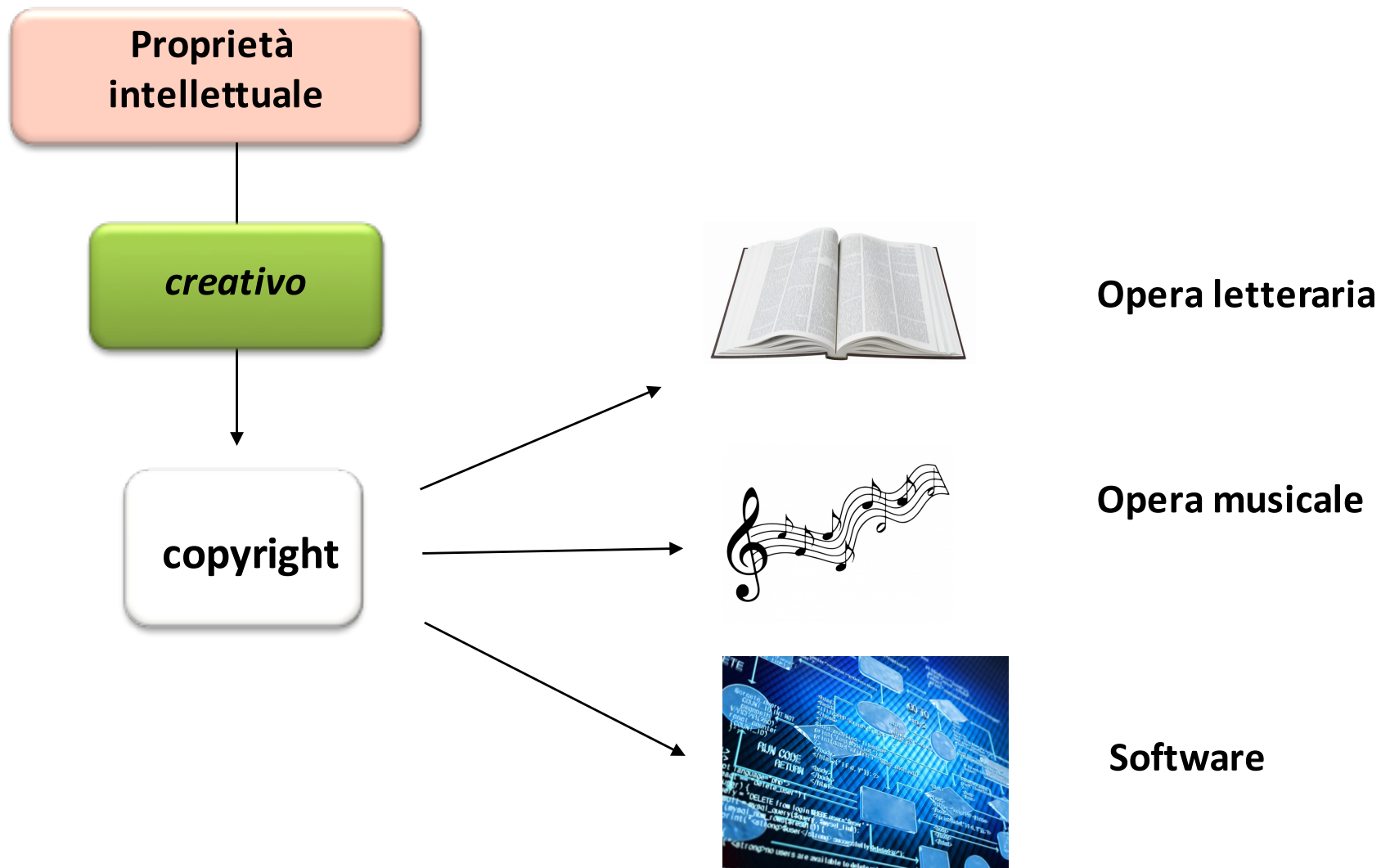

Software

➔ **Creazione Intellettuale espressa con un linguaggio simbolico**

Sequenza di istruzione (codice sorgente)



Applicato ad un hardware (codice binario)



Produce un risultato



Creazione Intellettuale espressa con un linguaggio simbolico

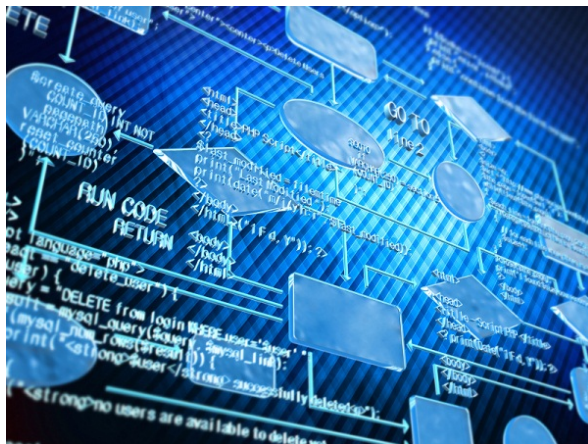

Codice sorgente



Codice binario



Valorizzazione

TRIPS Agreement

(Art. 9)

2. Copyright protection shall extend to **expressions** and **not to ideas**, procedures, methods of operation or mathematical concepts as such.

(Art. 10)

Computer Programs, whether in source or in object code, shall be protected as **literary works** under the Berne Convention (1971)

 ➤ **Copyright**

 ➤ **Marchio**

 ➤ **Dominio**

 ➤ **Dati**

➤ **Brevetto** 

Si può brevettare un software?

- ❑ I brevetti tutelano una soluzione: nuova, inventiva e con applicazione industriale.
- ❑ Art.52 EPC: esclude la brevettabilità del software in quanto tale.

Ma..



Se il software produce un effetto tecnico è brevettabile

Esempio pratico



“EP2791902 B1- METHOD FOR DETERMINING INHOMOGENEITY IN HUMAN LUNG TISSUE AND EQUIPMENT TO IMPLEMENT IT”

Titolare: FOND IRCCS CA' GRANDA
OSPEDALE MAGGIORE POLICLINICO

Inventori: GATTINONI LUCIANO
CADRINGHER PAOLO
CRESSONI MASSIMO

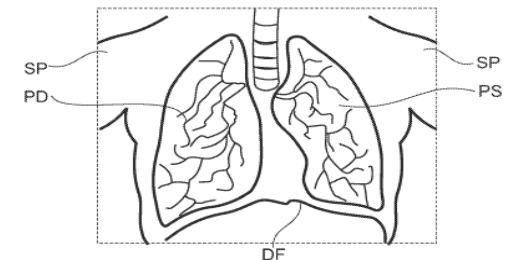

Fig. 1

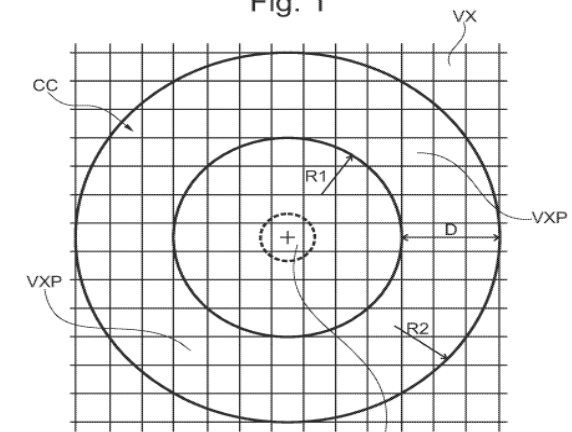
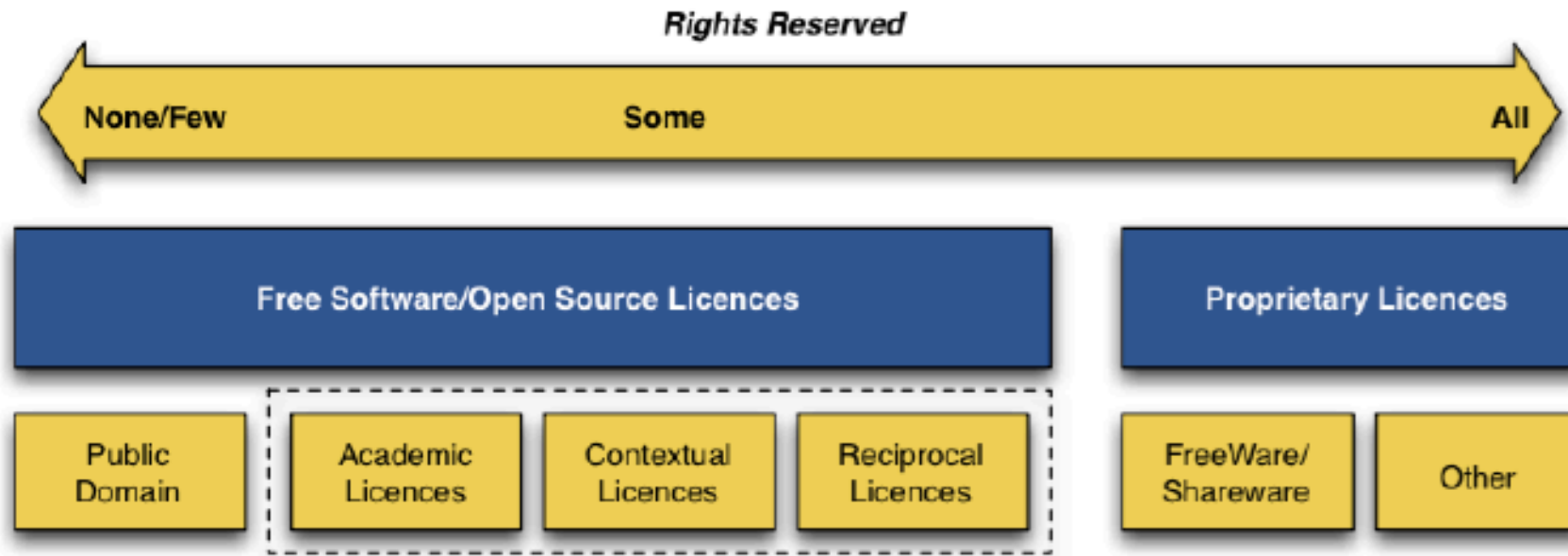

Fig. 2

Licenza d'uso del software



Source: European IPR Helpdesk

Licenza d'uso del software

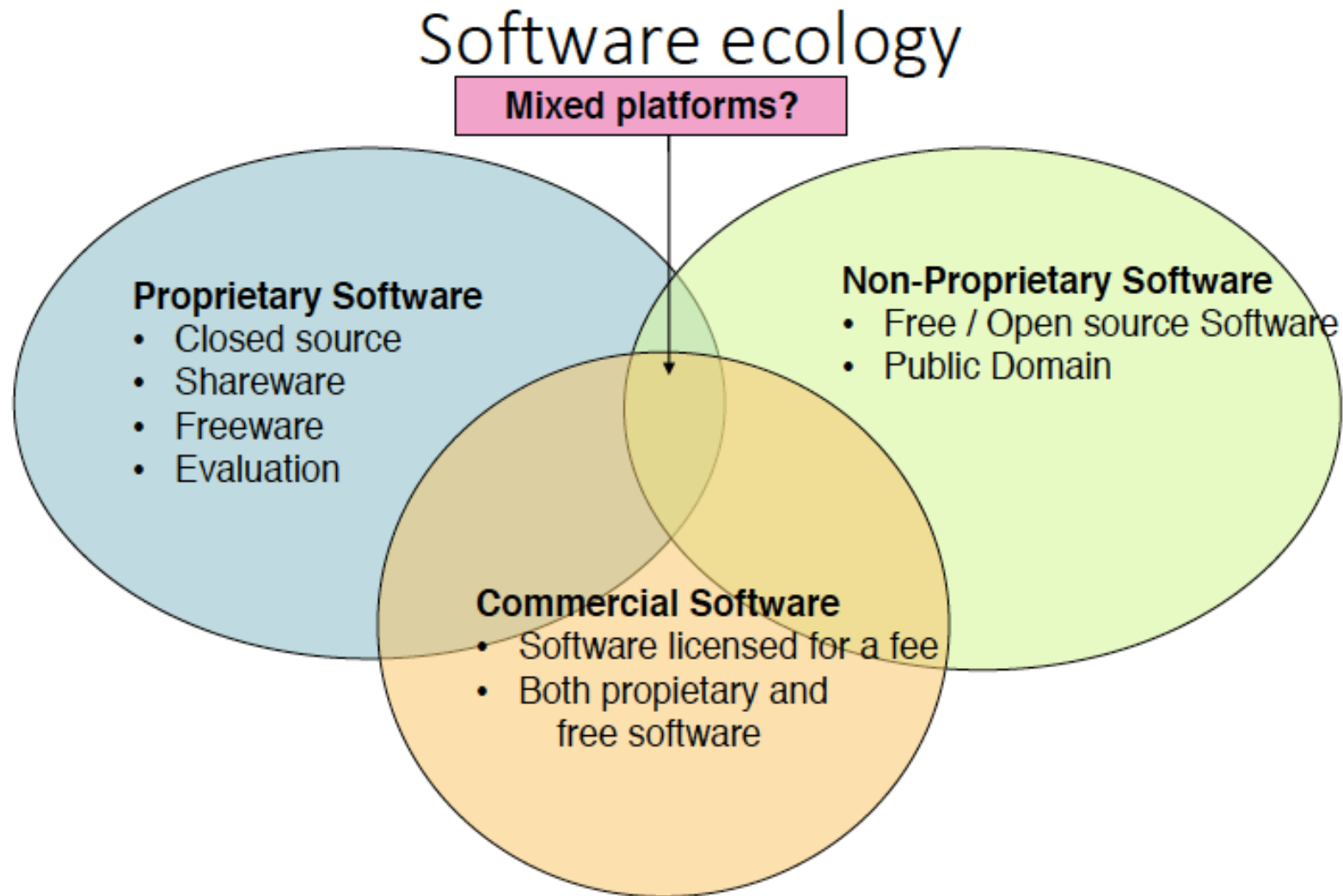

F O S S (Free and Open Source Software)

- ✓ software applicativi open source attualmente più diffusi sono [Firefox](#), [VLC](#), [Gimp](#), [7-Zip](#), [OpenOffice](#), [LibreOffice](#), [Rufus](#)
- ✓ altre famiglie di [sistemi operativi BSD](#), [GNU](#), [Android](#) e il [kernel Linux](#)

..to be continued....

Le Applicazioni Mobili (App)



Le Applicazioni Mobili (App)

Applicazione mobile (APP) è una applicazione **software** applicata ai **dispositivi mobili** (tablet/smartphone)



Software Development Kit

Le Applicazioni Mobili (App)

Applicazione mobile (APP) è una applicazione **software** applicata ai **dispositivi mobili** (tablet/smartphone)

Mixed platforms

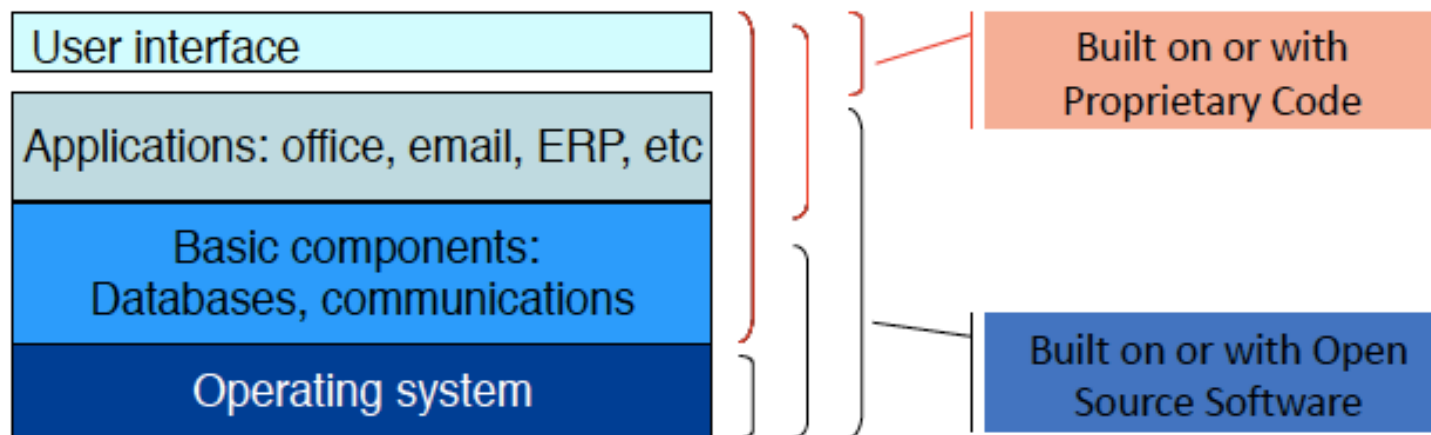

Source M. Bain – ASTP ©2020

Creare una app

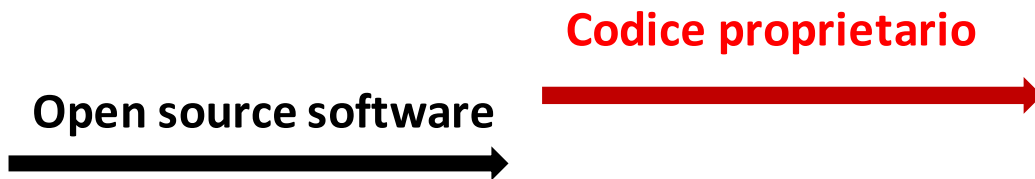

Progetto di App e relativo uso: check list

- ➔ **Realizzazione App (*Softwarehouse*) = interfaccia utente (*Client*)**
- ✓ **Aggiornamento** (nuove necessità; normativa (es.GDPR); ...)
- ✓ **Manutenzione e Assistenza**
- ✓ **Customer Care (medico, paziente, ricercatore, etc..)** (*Front end*)
- ✓ **Piattaforma per raccolta dati** (*Back end*)
- ✓ **Certificazione per gestione dati sensibili** (*Server*)
- ➔ ✓ **Certificazione “*store*” per la distribuzione**

Quale USO?

- **Raccolta dati** = TACCUINO
- **Calcolo di parametri** = STRUMENTO
- **Decisionale/ diagnostico** = MEDICAL DEVICE

CERTIFICAZIONE

Grazie per l'attenzione.

laura.spinardi@policlinico.mi.it

— www.policlinico.mi.it



Fondazione IRCCS Ca' Granda
Ospedale Maggiore Policlinico

Sistema Socio Sanitario



Regione
Lombardia